

BUBBLE

BY: JENNY LU

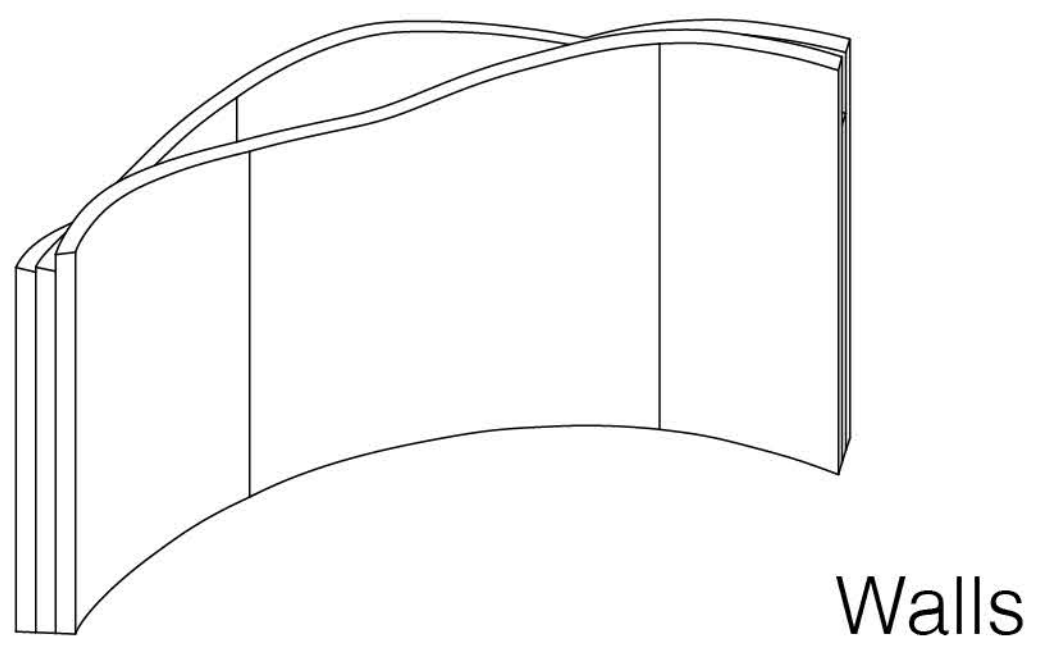

Walls

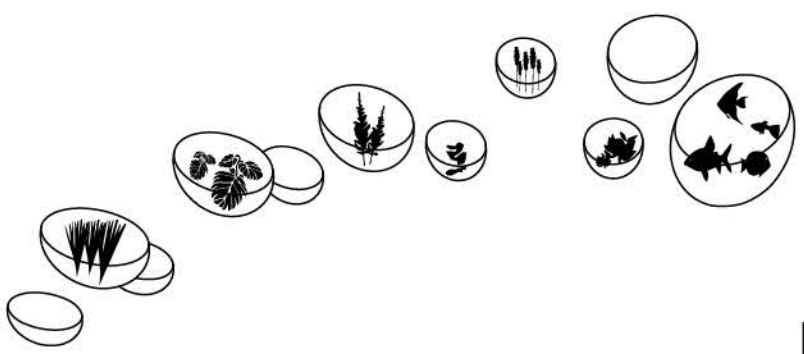

Fish & Plant Tanks

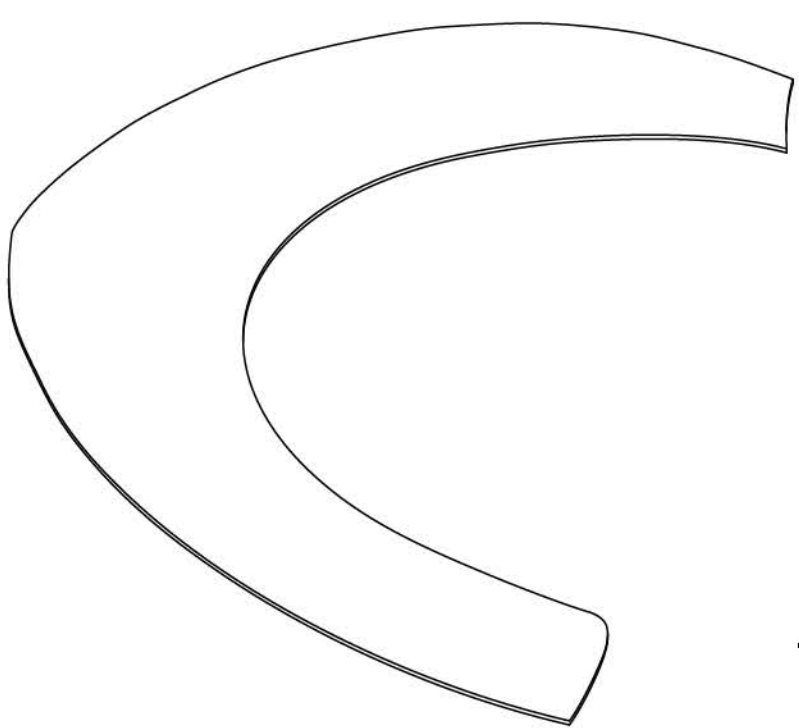
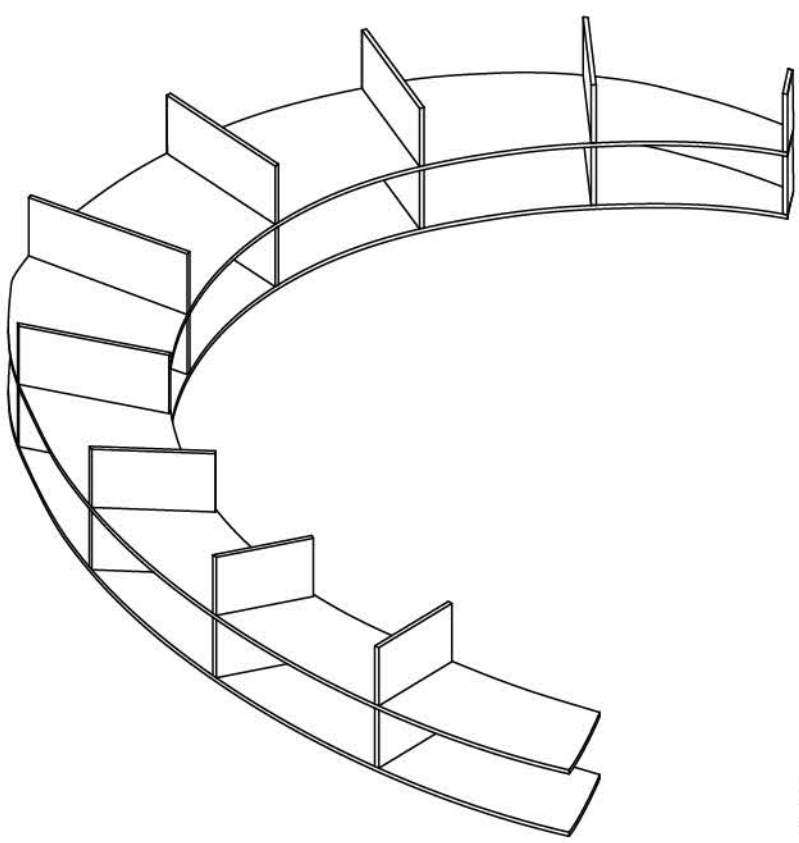
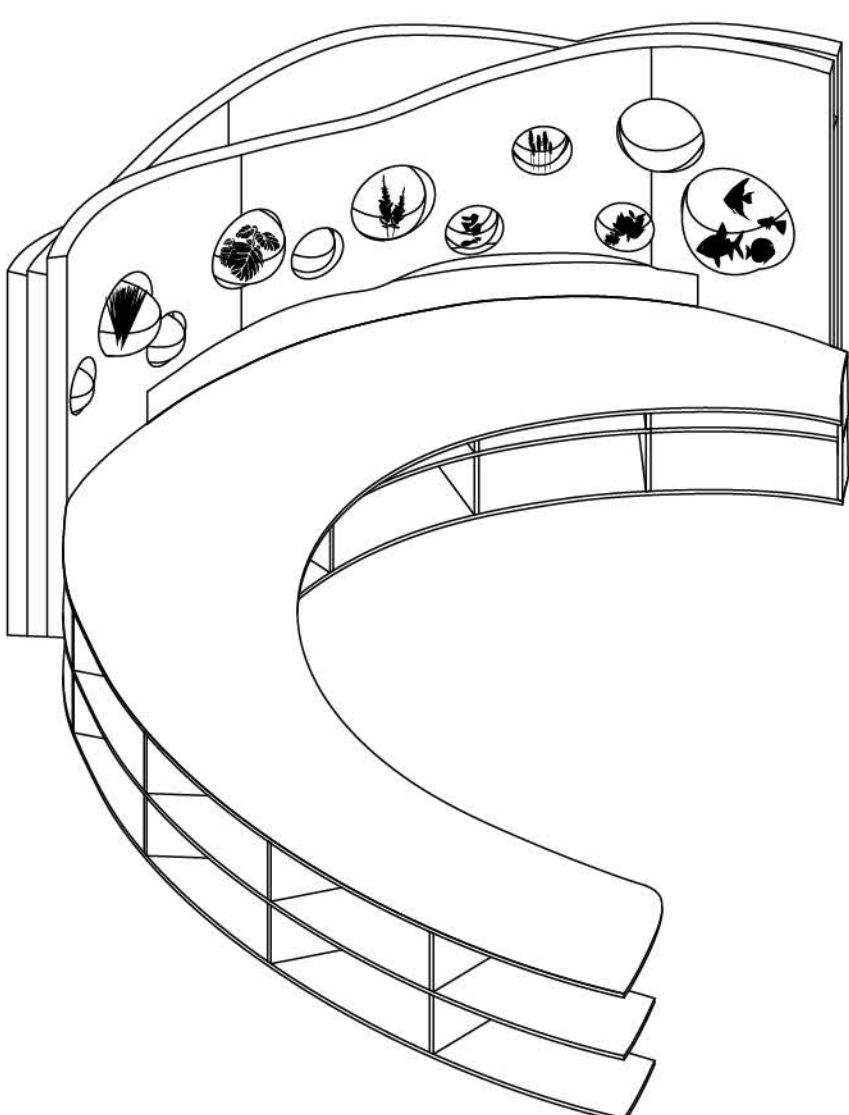

Table Surface



Shelving Units



Fish & Plant Wall-Table

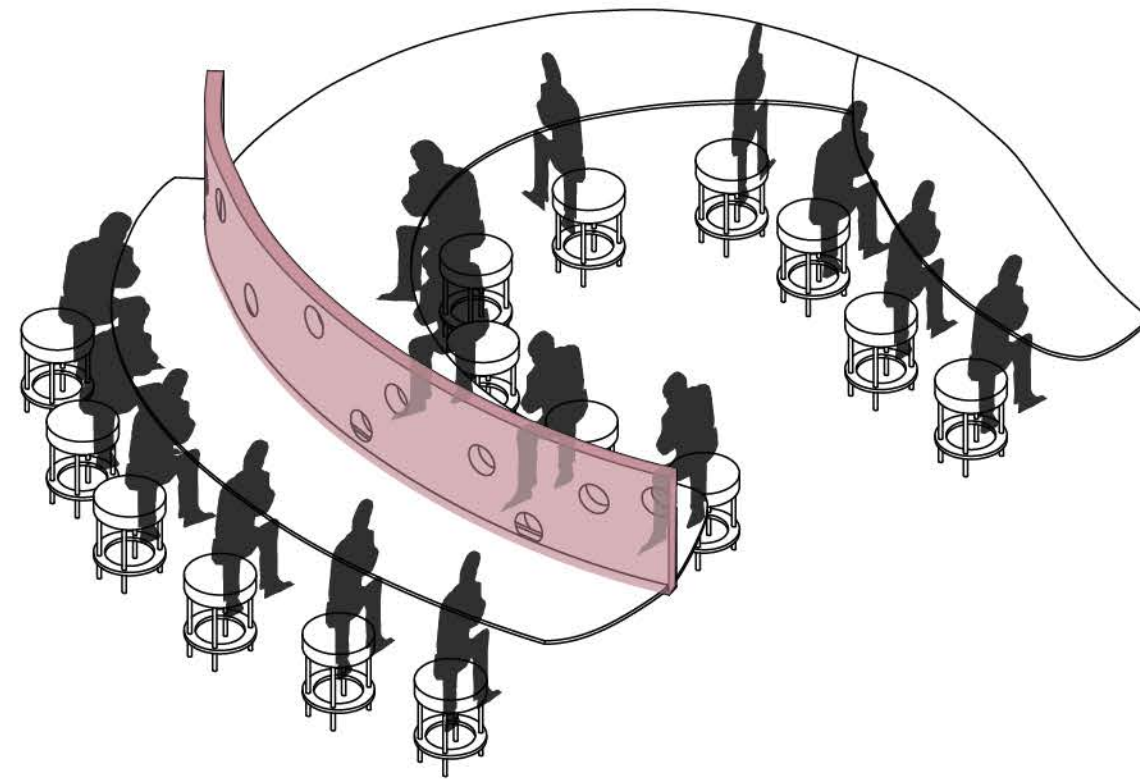

Individual Work

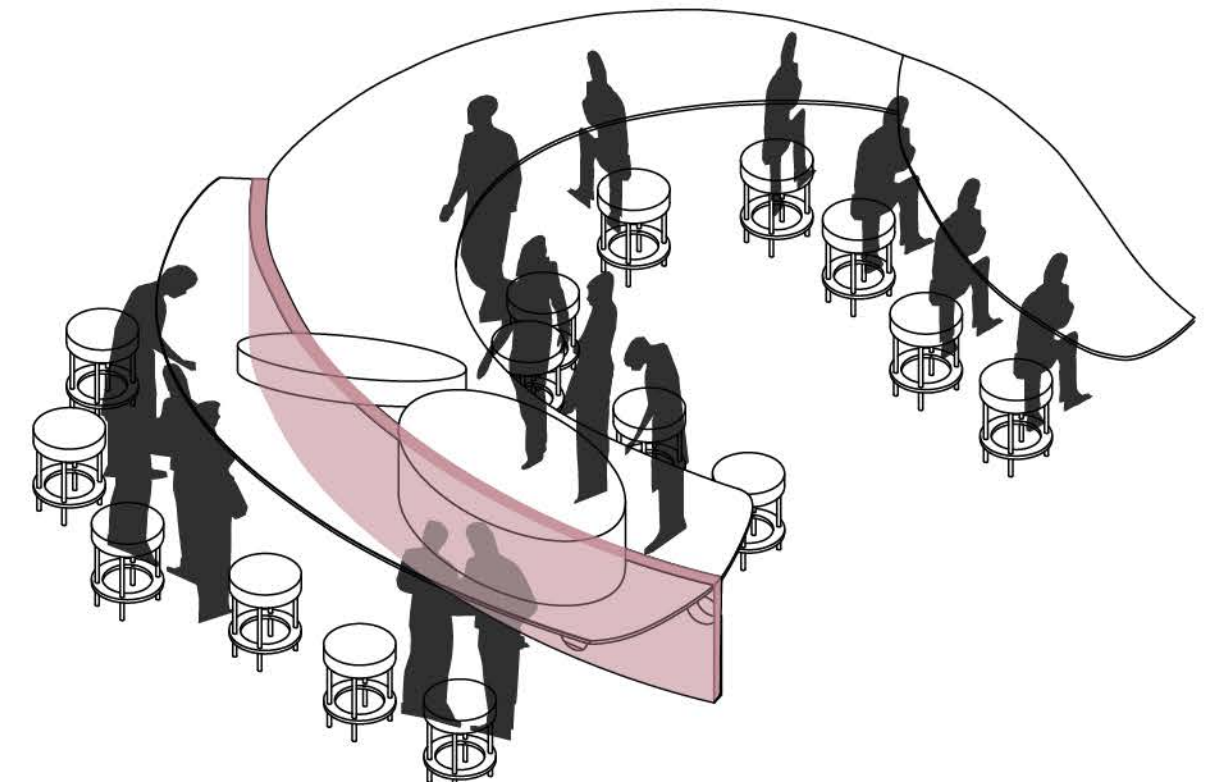

Group Work / Class Lecture

Movable Wall

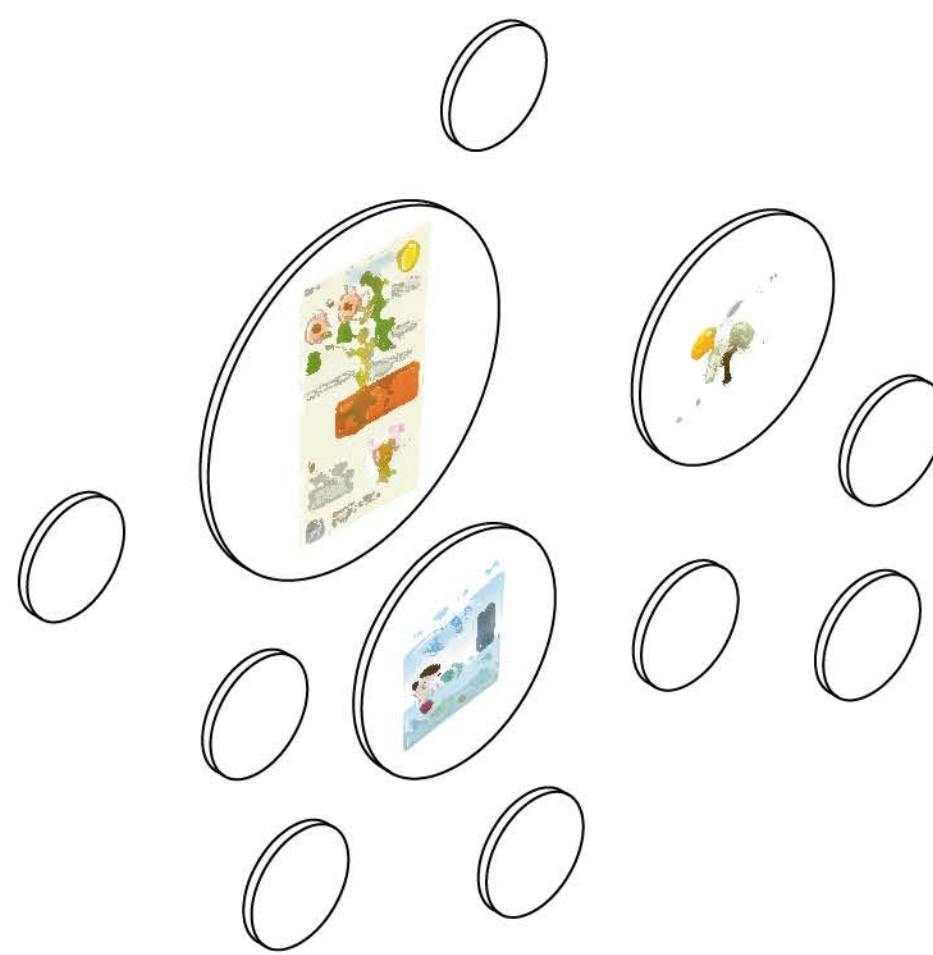

Cork Bulletin Boards

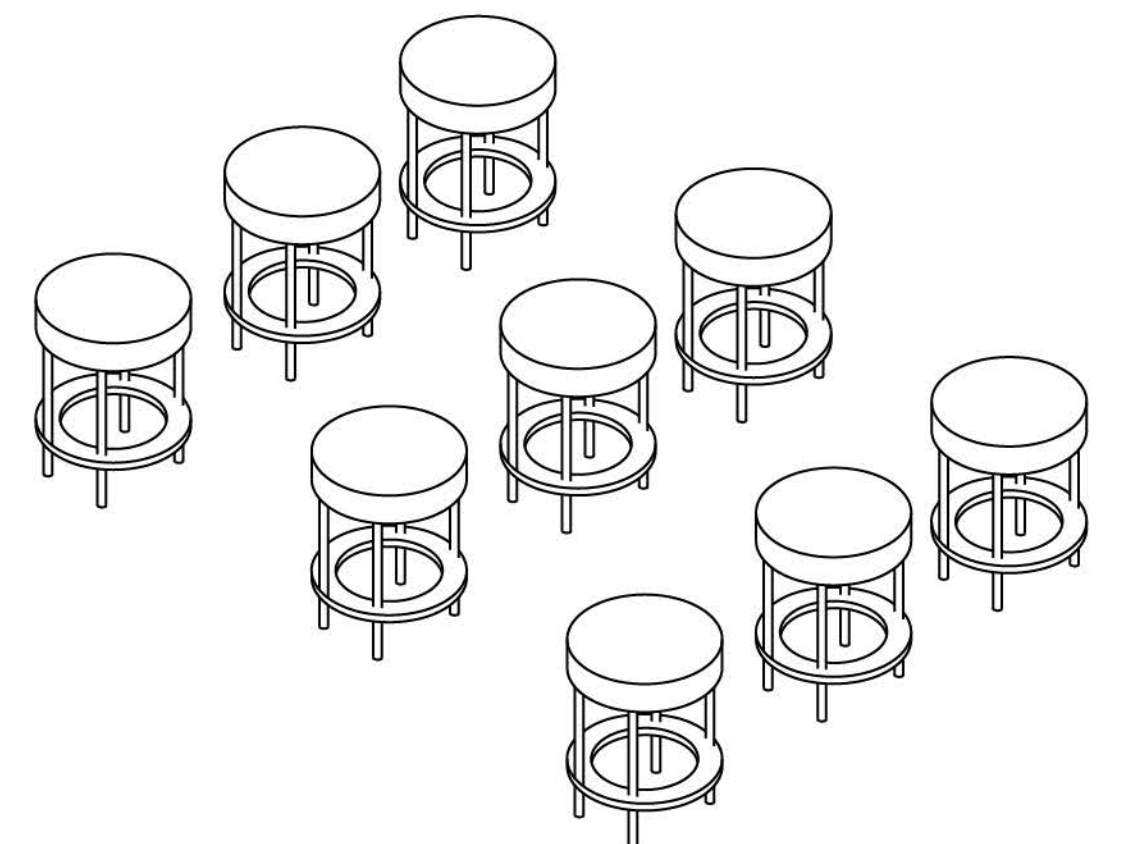

Cork Chairs
Reuse of Cork

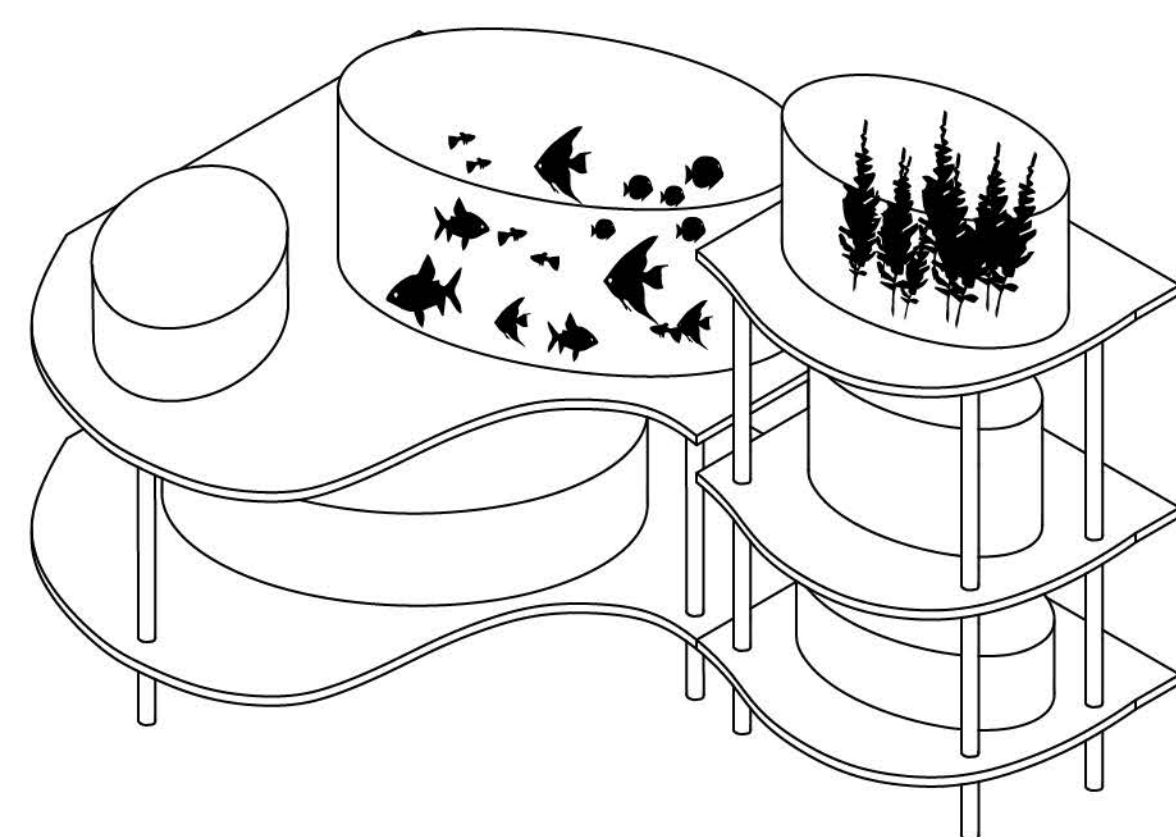

Aquaponics

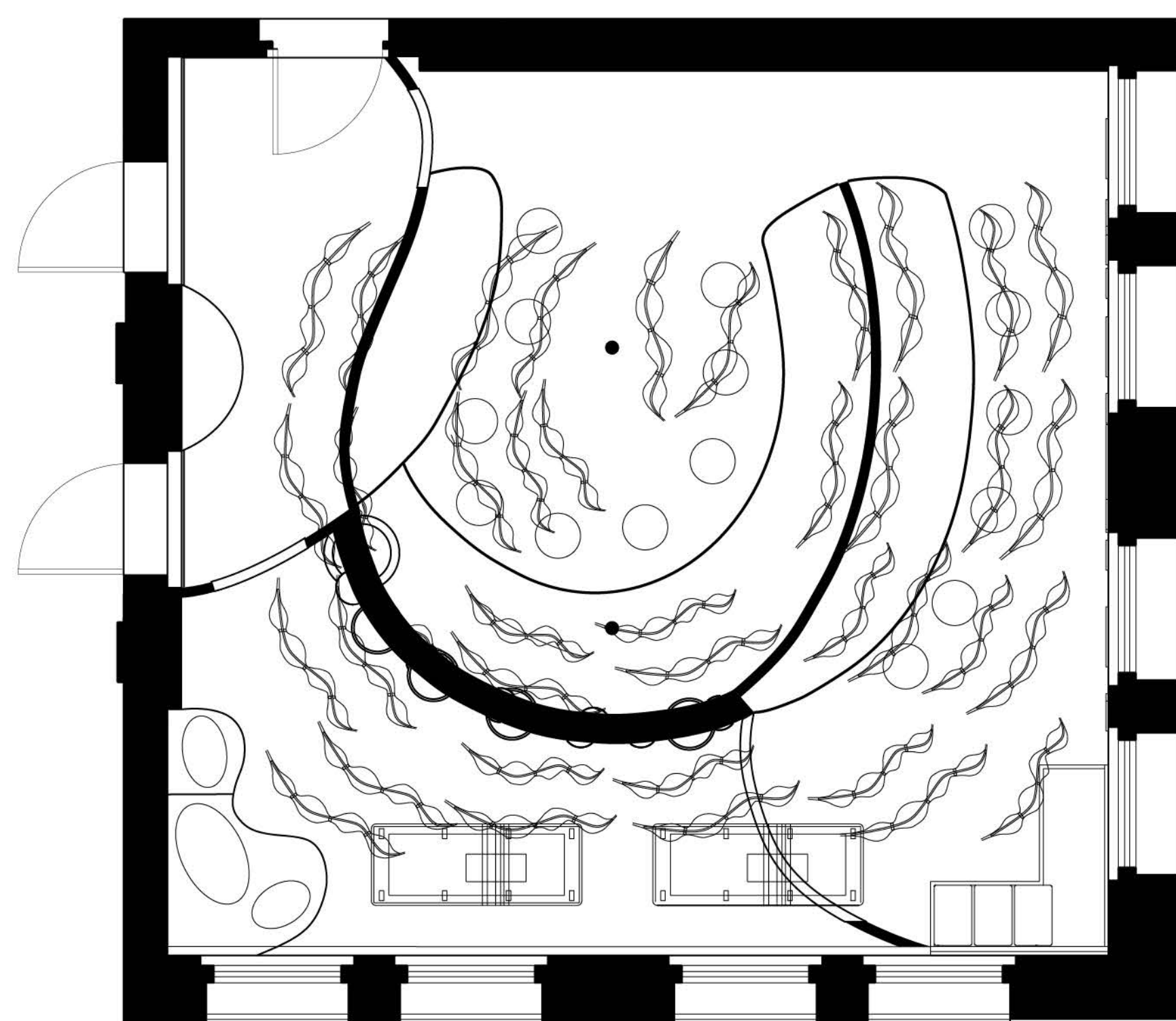

Lighting Pods
Following Form of
the Screens

Ceiling

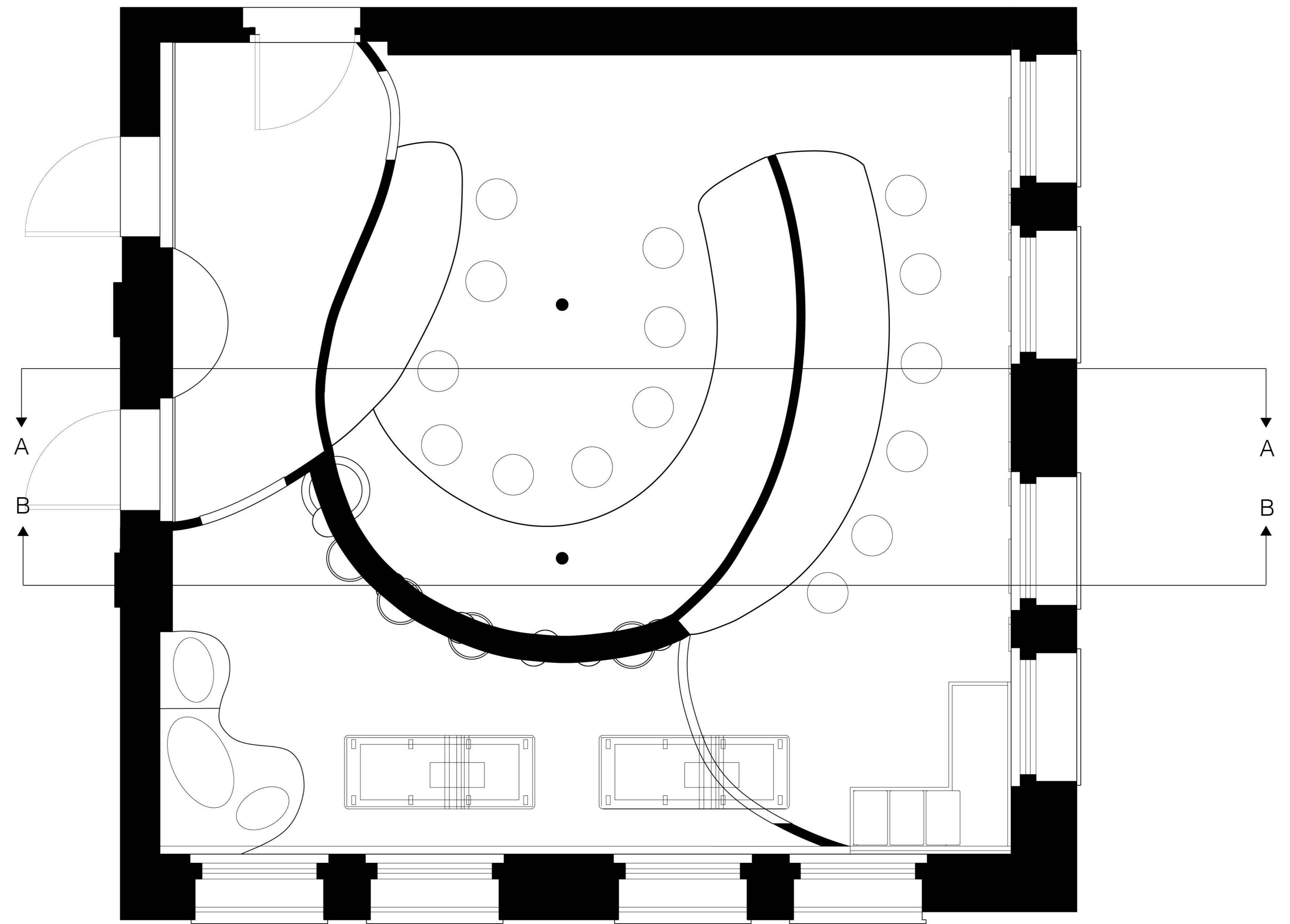
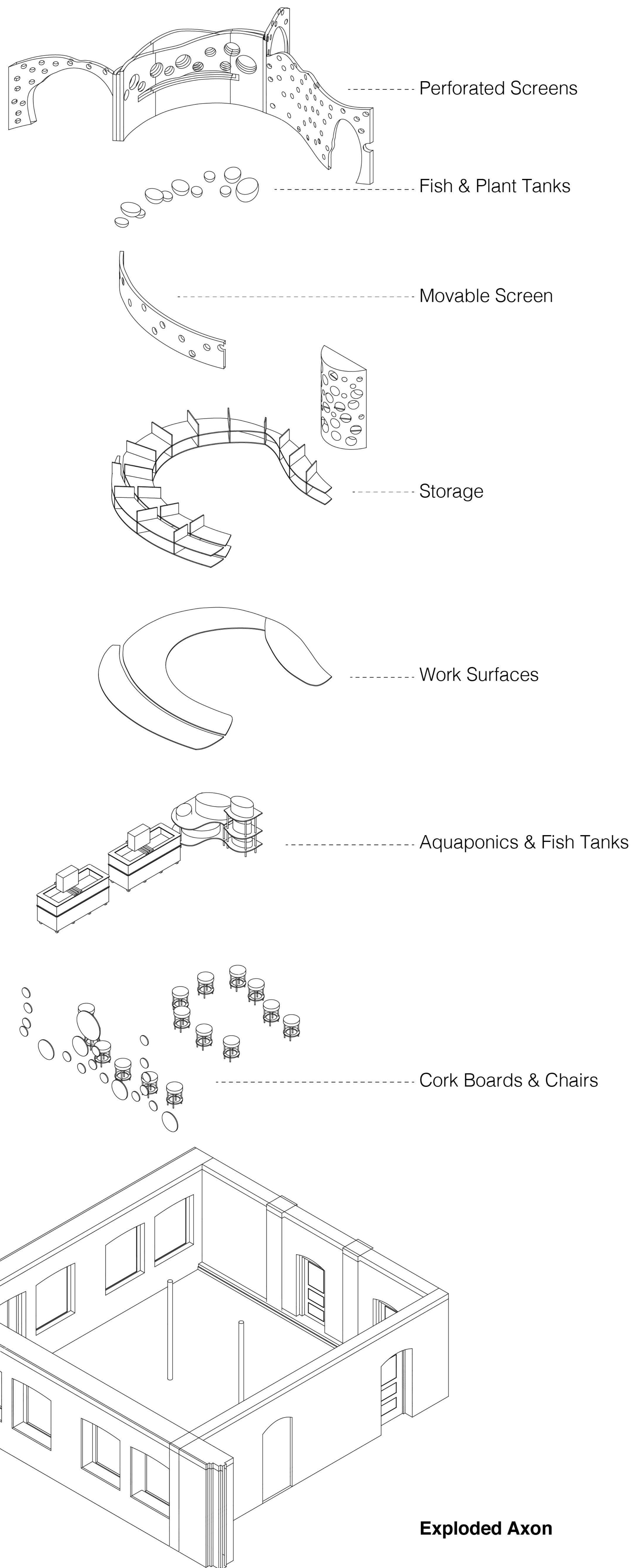

S: 1/2" = 1'0"



Section A-A



Section B-B

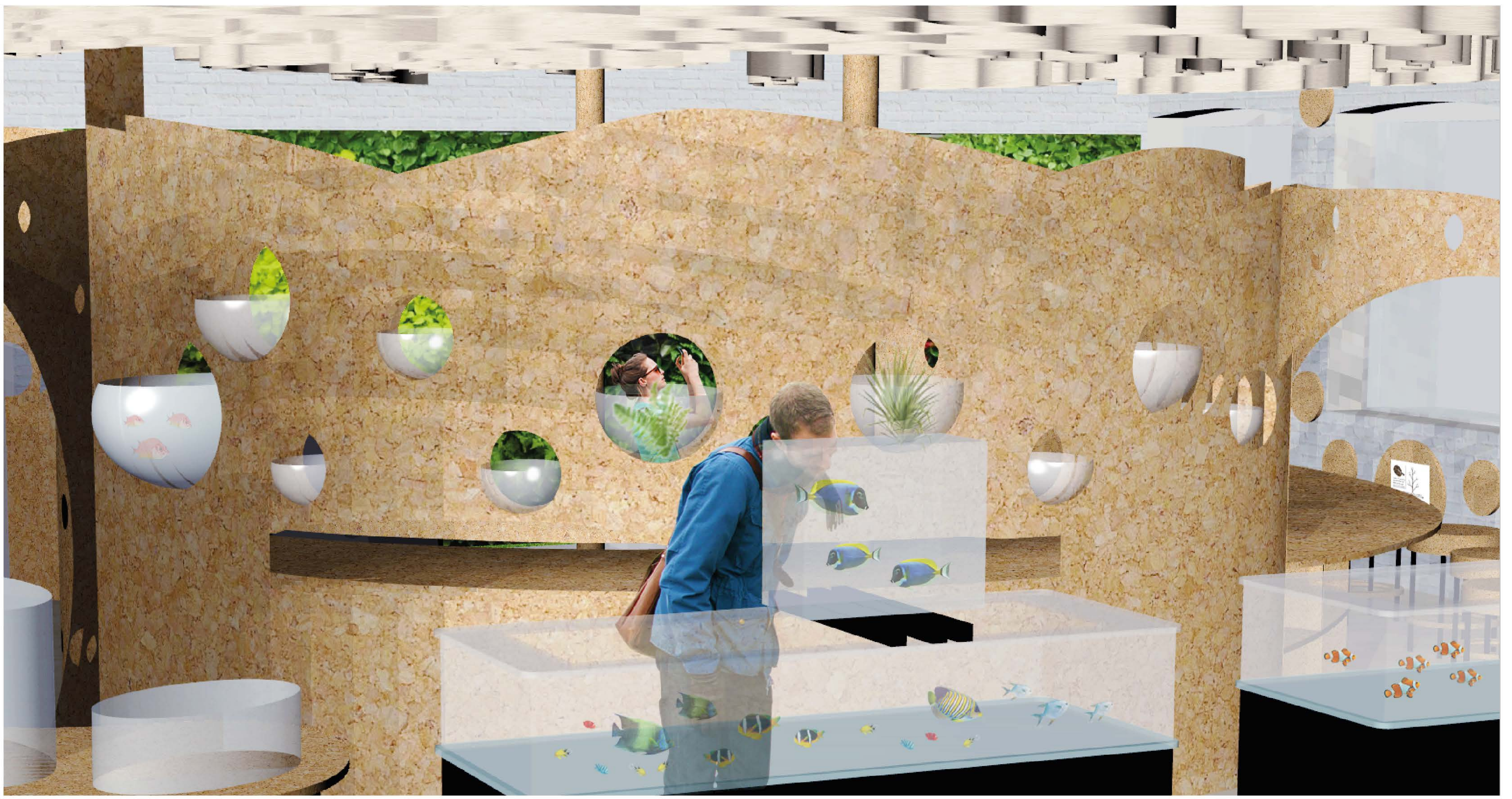

Prospect ----- **Interior**



Prospect ----- **Exterior**



Refuge

